

Smoke Vent System RZN 4402/04-K

operating instructions

**Safety system protects human life and material assets!
Once a year functional testing by a specialist company,
authorized by the manufacturer.**

These instructions must remain in control cabinet!

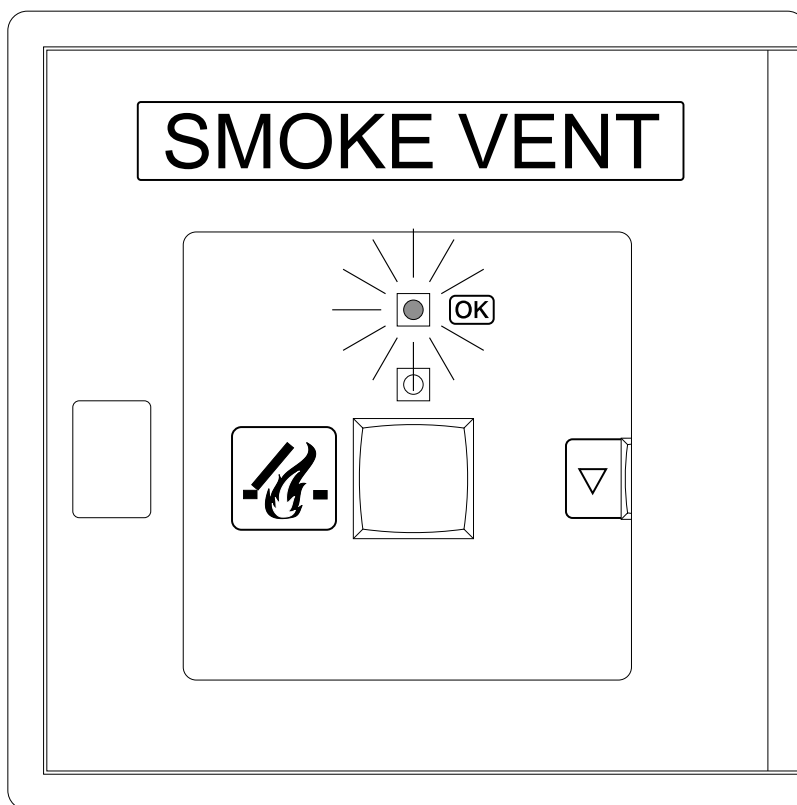

**Green control diodes must continuously lighten in buttons,
otherwise call for service!**



Release at alarm

Manual opening by smoke vent button:

Smash pane in smoke vent button!
Press red button !
Red display diode lightens in button and control panel.
Smoke vent opens.

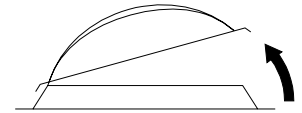

Automatic opening by fire detector:

Control diode lightens in released fire detector at alarm.
Fire detector stores alarm.
Red display diode  lightens in button and control panel.
Smoke vent opens.

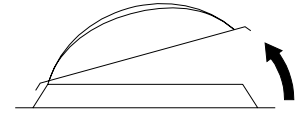

Automatic opening by melting fuse in control panel:

At a temperature of $> 72^{\circ}\text{C}$.
Red display diode  lightens in button and control panel.
Closing see "Emergency closing in case of not resettable alarm".
Smoke vent opens.

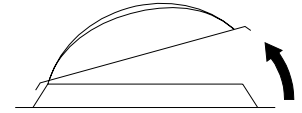

Automatic opening by external control:

Contact in external system closes.
Red display diode  lightens in button and control panel.
Smoke vent opens.

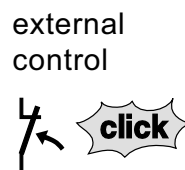

Closing after alarm

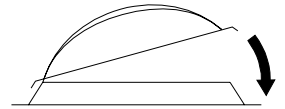
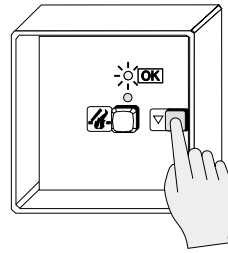

With manual release:

Press masked button ▽ in smoke vent button for 1 second. Red display diode  extinguishes in button and control panel. Smoke vent closes.



With automatic release by detector:

Wait until no more smoke in detector.

1. Switch OFF/ON line in control panel with push switch. Red display diode  extinguishes in button and control panel. Close smoke vent using vent button ▽ or
2. if dip switch 9 is switched on OFF, reset of smoke detector also possible by pressing button ▽ of the smoke vent button (for 1s). Red display diode  extinguishes in button and control panel. Smoke vent closes.

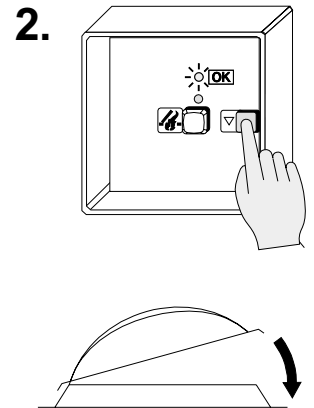
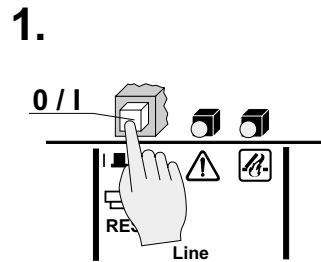

With automatic release by external control:

Open contact in external system, e.g. by reset of fire alarm system. Press masked button ▽ in smoke vent button for 1 second. Red display diode  extinguishes in button and in control panel. Smoke vent closes. *Only possible, if dip switch 5 on ON.*

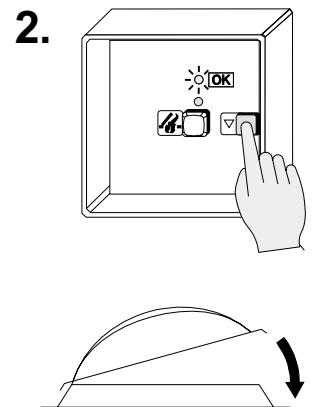
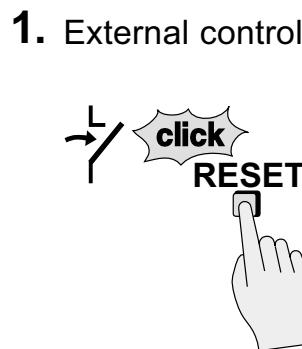

Emergency closing in case of not resettable alarm:

Switch-off line in control panel with push switch.

The system can be closed now using masked button ▽ in smoke vent button or vent button.

Call immediately for customer service!
Only possible when dip switch 9 on ON.

Note:

Control panel is automatically closing in case of power failure, if dip switch 4 and 5 is switched on ON.

1.

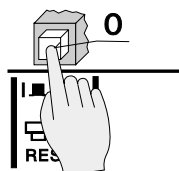

2.

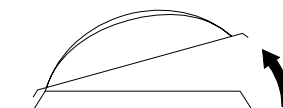
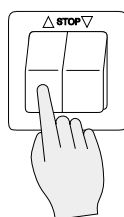
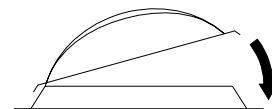
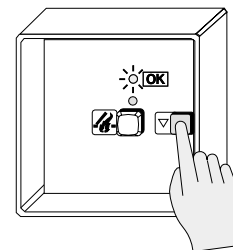

Day-to-day ventilation:

Press vent button △ or ▽.

Window opens or closes up to final position. The window can be stopped at any intermediate position by pressing simultaneously both buttons.

This function does not work in case of power failure or when alarm by the smoke and heat vent system is indicated!

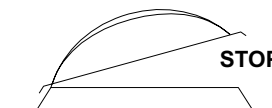
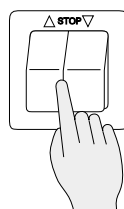
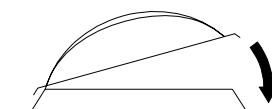
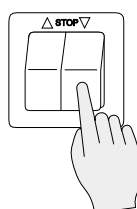

Only if wind detector or rain detector available

A relay contact in the rain detector connects in case of rain or if the wind vane contact connects in case of wind velocities of approx. 8 m/s, corresponding to wind-force 4-5.

The system closes in case of wind or rain, if the weather automatic is switched-on by vent button **LT 43U-W** or if a wind/rain detector is directly connected.

The system does not automatically open again, if wind or rain stops. Opening of the system for ventilation via vent button. In case of alarm, the system opens also in case of wind and rain via smoke and heat vent system.

Do not ventilate via smoke vent button, because danger of damage caused by wind or water.

The weather automatic can be switched-off at vent button **LT 43U-W**, if gap ventilation is required because of bad weather.

Gap ventilation is not possible in case of bad weather, if no vent button **LT 43U-W** available. For further notes see **information for use WRM / REM 42**.



Smoke Vent System RZN 4402/04-K

installation

**Safety system protects human life and material assets!
Once a year functional testing by a specialist company
authorized by the manufacturer.**

Connection, mounting and functional testing by a specialist company authorized by the manufacturer.

Green control diodes in the buttons must constantly lighten, otherwise see "Informations for Starting".

Repair power failure at once. Emergency power supply for 72 hours.



**RZN 4402-K
RZN 4404-K**



**Approval-No:
G 501002**
for smoke vent
control panels
RZN 4402-K/ KS

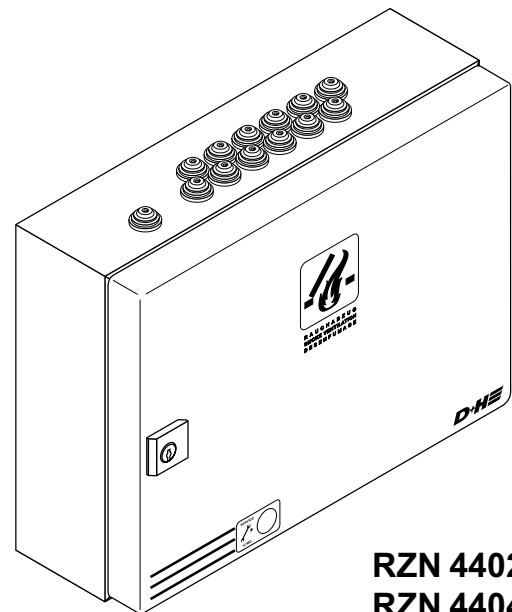

**RZN 4402-KS
RZN 4404-KS**

Guarantee

You will get **2 years** guarantee for all D+H products from date of verified handing over of the system up to maximal 3 years after date of delivery, when mounting and starting has been carried out by a D+H authorized **distributor**.

D+H guarantee is expired, with connection of D+H components with external systems or with mixing of D+H products with parts of other manufacturers.

99.821.26 Rev.: 2.8

Content

Guarantee	1
Technical Data	2
Maintenance	2
Introduction	3
System overview	4
Mounting of housing	5-6
View motherboard RZN 4402/04-K	7
Drives and smoke vent buttons	8
Wiring plan	9
Connection cable	10
Connection	11-13
Starting	14
Encode of line and group	15
Examination	16

Technical Data

Control panel type	: RZN 4402/4404-K / KS
Rated voltage	: 230VAC, 50Hz
Rated capacity	: 60VA/120VA
Interfering emission	: EN 50081-2 EN 55022
Res. to jamming	: EN 50082-1 EN 61000-4-2 to -6 EN 50204
Protective category	: II / I
Fire resistance	: -5 to +40 °C
Protective system	: IP30 / IP54
Class of rating	
- Monitoring	: Continuous duty
- Emergency state/ ventilation	: Short-time duty
Output voltage	: 24V=/res. ripple <10%
Safe output	
- rated current	: 2A / 4A
VdS approval No for RZN 4402-K/ KS	: G 501002

24 V Emergency Supply:

Emergency power supply for 72 hours
Use VdS approved storage batteries only.

RZN 4402-K:

2x 12V / 1,2Ah ±0,2Ah

With connection of alarm devices:

2x 12V / 2,2Ah ±0,3Ah

RZN 4404-K:

2x 12V / 2,2Ah ±0,3Ah

Maintenance

Once a year by a specialist company, who is authorized by the appliance manufacturer.
Renew test badge, keep control book.

The respective current D+H maintenance instruction is decisive.

D+H authorized expert companies have been specially trained by D+H for carrying out expertly this maintenance, and they get automatically the latest maintenance instructions.

Following tests must be carried out in the course of maintenance:

- Outside examination / inspection of system components
- Measuring of insulation resistances
- Checking of all relevant power supply units
- Functional testing of connected system components
- Record of competent carrying-out of maintenance, and designation according to directions

Information

An overdue maintenance of the system will be indicated by the control panel after about 16 months. The yellow control diode in the smoke vent button RT43-H will start flashing.

A malfunction in the smoke vent system will be continually indicated by the extinguished green control diodes in the smoke vent buttons.

After the maintenance time is expired (16 months), the ventilation function OPEN can be interrupted depending on the presetting of the service timer. Reset can be carried out by a specialist company only, who has been authorized by the appliance manufacturer.

Introduction

Smoke and heat vent systems (RWA´s) are very important elements of structural preventive fire protection.

Smoke and heat vent systems are appliances of preventive fire protection. They fulfil important functions in case of fire: protection of human life by providing a smokeless layer, by which rescue routes are kept free for the fire-brigade. Consequential damages by conflagration gases are reduced, and considerable material assets are protected from destruction. Precondition for this is absolutely reliable functioning of the systems in case of fire. Only electrical specialist companies are authorized to install these systems, who have electrical specialist staff with relevant experiences in installing danger alarm systems or smoke and heat vent systems. Only these ones can take on responsibility for functioning, and can ensure product liability for the whole system (see product liability law BGBL.I S.2198 and BGB (bodily injury, compensation for damage)).

Therefore, regular maintenance and checking of functional readiness is imperative and has to be ensured. These standard requirements are demanded according to regulations of the DIN, of the Association of German Insurer against damage of property (VdS) and the respective local authorities. Recommended is, that maintenance work should be carried out by authorized specialist companies, only.

Only regular and professional maintenance warrants the necessary and permanent functional safety.

Only authorized specialist companies are allowed to install and maintain smoke and heat vent systems and system components, constructed and distributed by **D+H**. All **D+H** partners belong to these authorized specialist companies, who regularly undergo an in-house training to ensure their qualification and experience.

Smoke and heat vent systems must be maintained at annual intervals by authorized specialist companies according to DIN 18232 section 2 paragraph 7.2, and VDE 0833 section 1 paragraph 5.3.2 + 5.3.4 for alarm systems, VdS guidelines 3/93 supplementary sheet form 3010, type-building regulation May 1990 and manufacturer guidelines.

According to VDE 0833 accumulators for emergency supply (lead accumulators) must be checked every six months by a person, who has been introduced to this task, and once a year, maintenance must be carried out by specialist companies (see to this point DIN VDE 0108 section 1 paragraph 9.1.1). Accumulator types, which are used for **D+H** smoke and heat vent systems must be VdS approved, and must be released by **D+H** to use in smoke and heat vent systems. According to DIN 18232 section 2 paragraph 7.2 the tests must be put down in an operational book, which the operator/ building owner must present to the building supervision authority on request. This operational book is component of every **D+H** smoke and heat vent system.

Executed maintenance must be proved by a **D+H** maintenance/ and testing confirmation.

Important Regulations

Observe regulations for danger warning systems VDE 0833, guidelines for electrical systems VdS 2221, VdS 2580, VDE 0100, DIN 18232 for smoke and heat vent systems, regulations of the local fire-brigade and of EVU for connection to mains supply.

System Overview

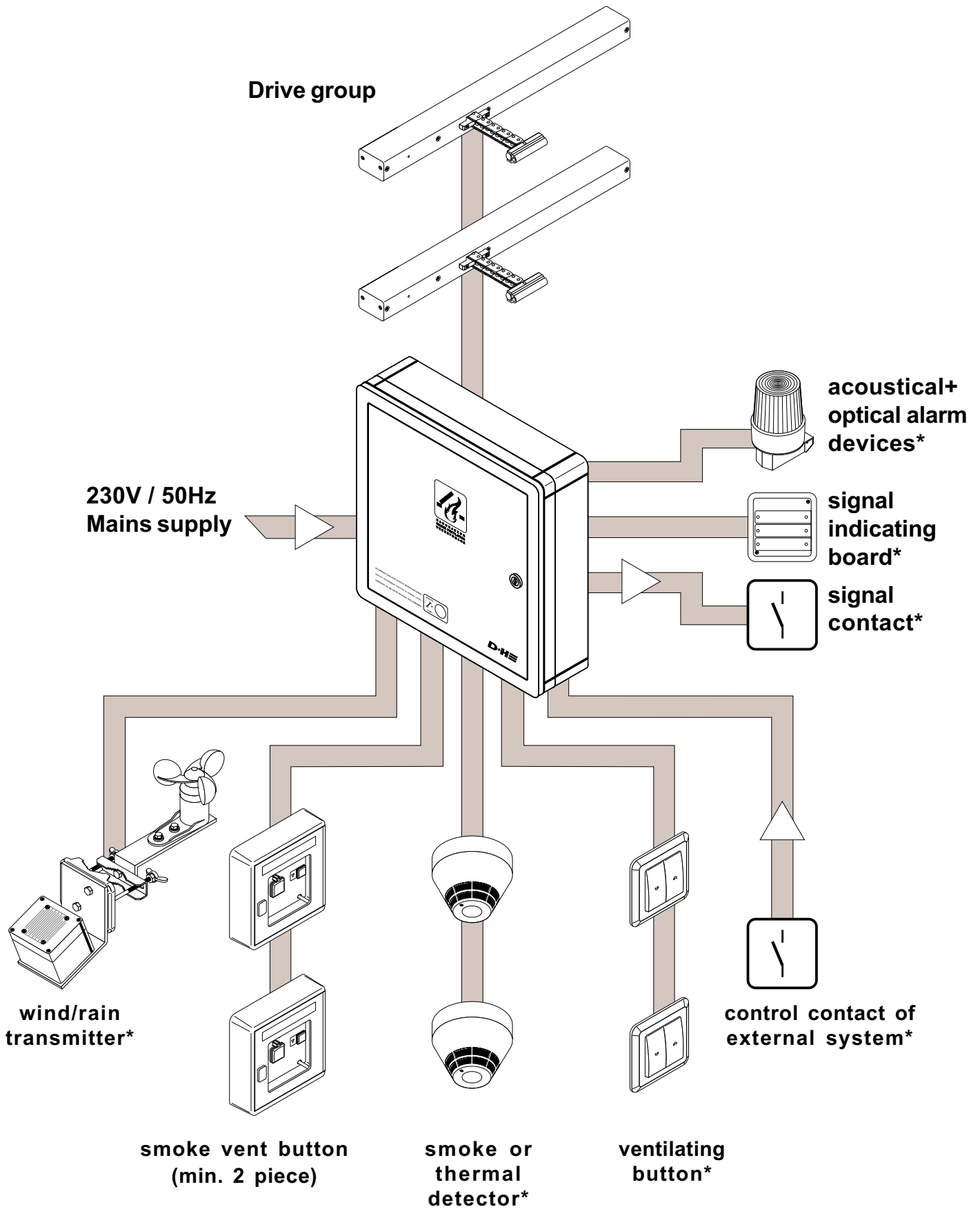

*** optional function extension
(separate components. Retrofittable!)**

Mounting of housing 1

Dimensions WxHxD: 250 x 250 x 91mm
 recessed dimension for flush mounting WxHxD: 262 x 262 x 81mm

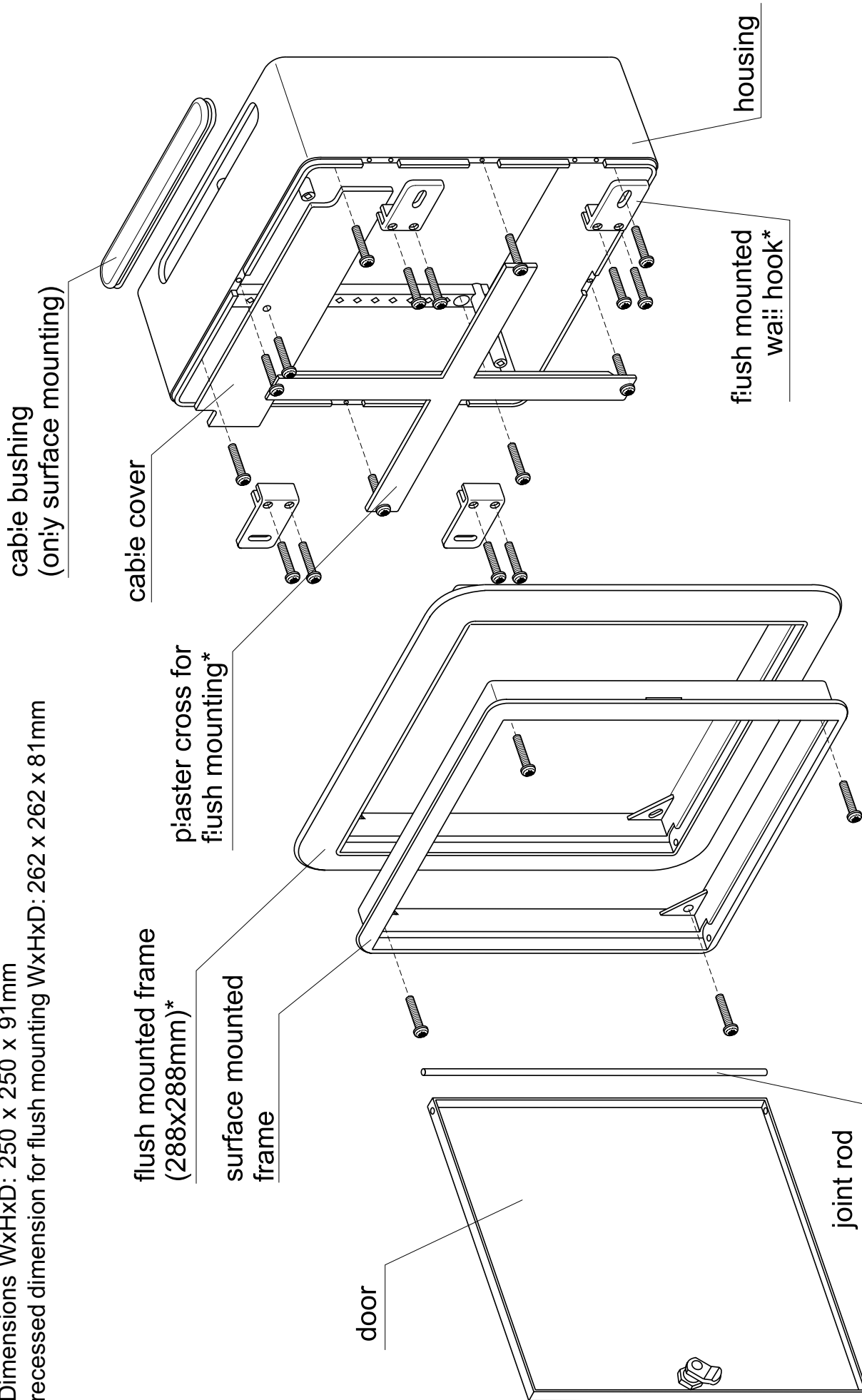

* optional: flush mounted set UPS 44-K
 (not for hollow way mounting)

Mounting of housing 2

Mount control panel sheltered and easily accessible for maintenance in proximity of drive

Surface mounting:

1. Remove cable cover
2. Fasten housing trough with 4 screws at wall

Flush mounting

(not hollow wall mounting):

1. Screw down wall hook and plaster cross at housing trough
2. Fasten housing trough in niche and remove plaster cross again after plastering

Attention: Fire resistance category of fire walls must not be inadmissibly influenced. Sound insulation is impaired by flush mounting.

Final mounting:







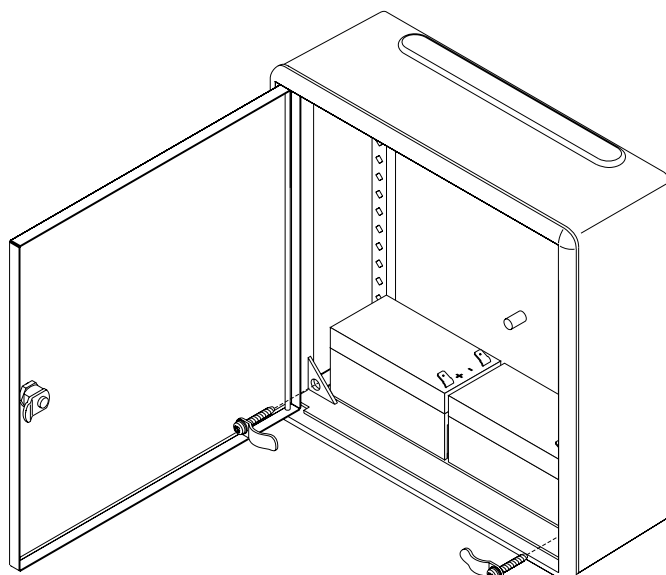

3. Mount and connect central pcb
4. Screw down cable cover
5. Unhinge door of the door frame (for this, press joint rod upwards using pliers). Fasten door frame on housing trough, and hang door on it's hinges again

Fastening of accumulators

Only RZN 4404-K.



Piktograph explanation

	Smoke and heat vent alarm
	Control panel O.K.
	Fuse actuator
	Mains existing
	Vent button function "ON"
	Vent button function "OFF"
	Charging voltage controller
	Battery

Covering

Place enclosed covering cap over supply terminal after mains cable has been connected.

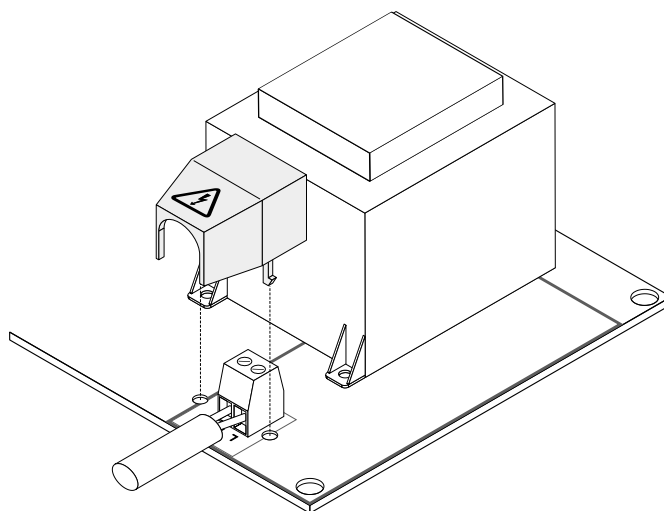

View motherboard (RZN 4402/04-K)

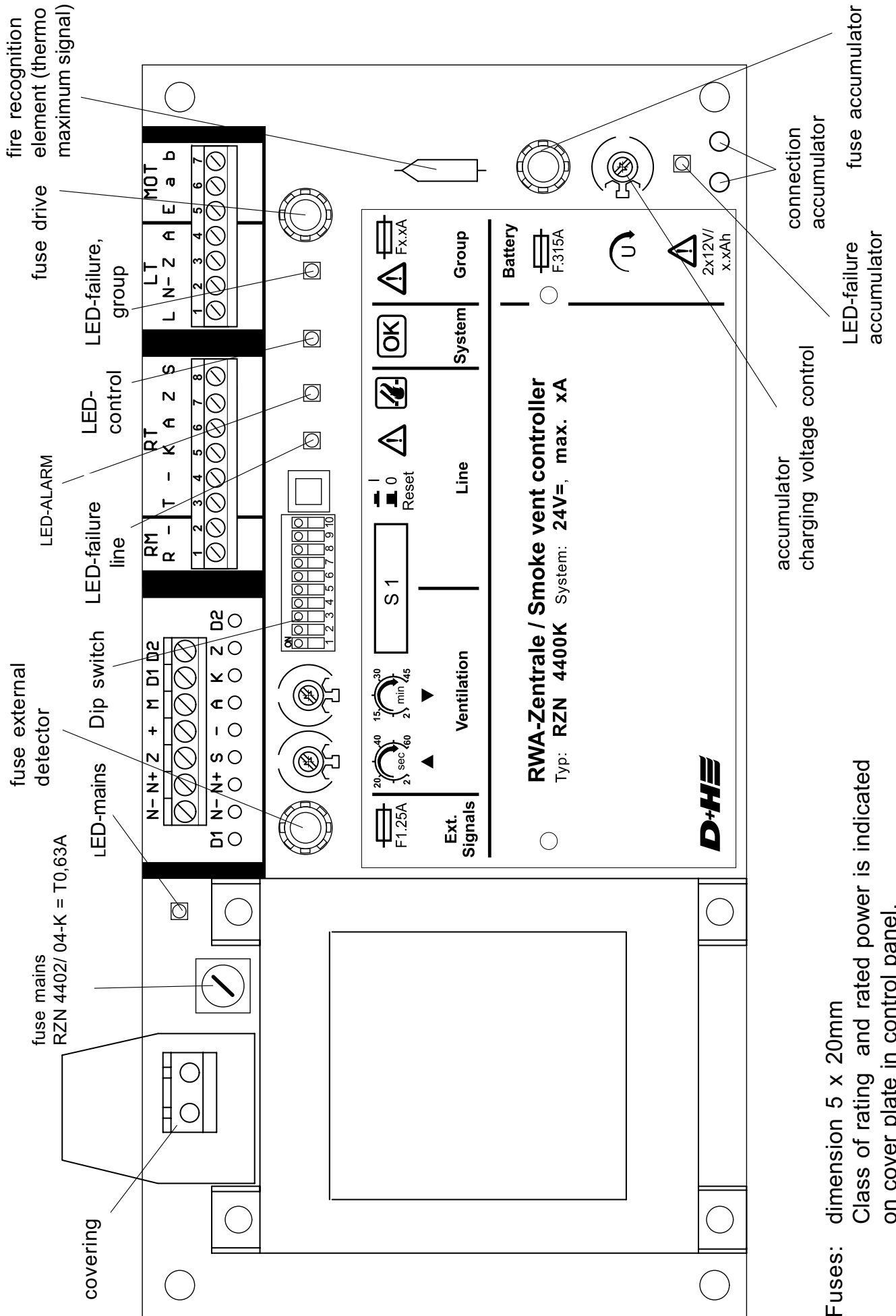

Fuses: dimension 5 x 20mm
 Class of rating and rated power is indicated on cover plate in control panel.

Drives

Smoke and heat vent opening:

Smoke gases are to be carried off as unhindered as possible through smoke and heat vent opening in case of fire.

According to relevant rules, openings have to be placed always in the upper part of a building.

The smoke and heat vent opening can be mounted in the wall as well as in the ceiling. Size, kind and arrangement of the opening is of decisive significance for an optimal effect of the smoke and heat vent system.

The important thing here is, that an escape must not be hindered by the window wing itself, by structural facts like offsets, or the like.

Minimum ventilating surface is given by legal regulations and structural facts. In staircases the ventilating surface is 5% of the floor surface according to LBO, however, at least 1m².

Ideally the opening angle should be circa 70°, because only then clear dimensions of the smoke and heat vent flap are taken into account in valuation.

The valuated sizes of opening angles of smoke and heat vent systems must be in agreement with the responsible fire protection authority.

Observe! Window wings, opening inward, must not project in escape/ and rescue routes and obstruct them.

Mounting of the drives:

Please take mounting informations from the relevant instruction for use of the respective drive, because of varied possibilities for choosing drives.

ATTENTION:

When Dip switch 10 is on ON, the smoke vent will be triggered with an OPEN-impulse every 2 minutes for a duration of 30 minutes according to VdS 2581. For this, the drive must be blockage safe according to VdS 2580 par. 4.7. . All D+H drives meet this precondition. Otherwise Dip switch 10 is to be switched on OFF.

Smoke Vent Button

Place(s) of mounting:

Maximal 12 smoke vent buttons can be connected.

Main control must be mounted on ground-floor according to VdS 2595 and VdS 2221.

Secondary control is to be installed in all other floor levels according to VdS 2595 and VdS 2221.

Install buttons so, that they are accessible any time and clearly visible.

Mounting height:

1,5m above upper edge of firm flooring.

Fastening:

With plug screws 4,5 x 40mm diagonal, or direct on 55mm flush box with 2 screws.

Housing colour:

Standard: deep orange (RAL 2011), according to VdS 2592.

However, deviating colours might be locally required (blue, yellow, red).

Please consult your D+H distributor.

Wiring Plan (Paragon)

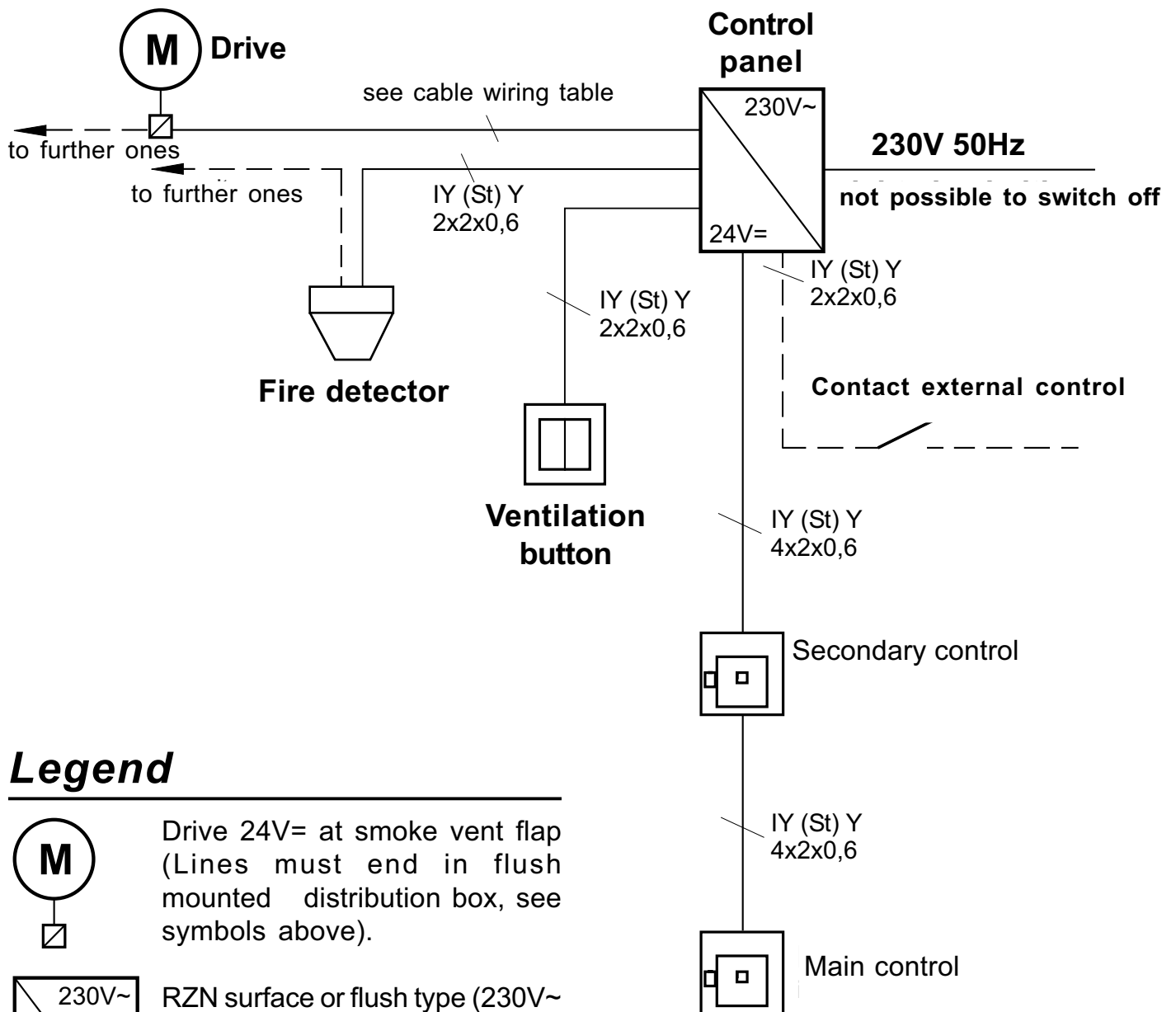

Legend

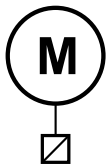

Drive 24V= at smoke vent flap (Lines must end in flush mounted distribution box, see symbols above).

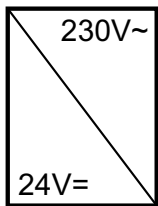

RZN surface or flush type (230V~/24V=) in proximity of smoke vent flap.

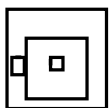

Smoke vent button (e.g. RT43-H/N) surface 24V= circa 1,5m above upper edge firm flooring (by customer 55mm flush socket)

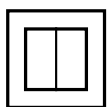

Vent button 24V= (e.g. LT43) circa 1,2 above upper edge firm flooring (at flush type by others 55mm flush socket)

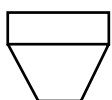

Fire detector 24V= (e.g. FO 1362 or FT 1262)

230 V Supply

Provide for separate electric circuit.

Mark fuses.

Plug covering cap over mains binder on motherboard of control panel.

Connecting cable: NYM-I 3x1.5

Connecting load: RZN 4402-K = 60 VA
RZN 4404-K = 120 VA

Weak Current Lines

Install and feed separately from supply mains.

Mark cable and terminal box red.

Cable for D+H Smoke and Heat Vent Systems

The smoke vent control panel is designed for opening smoke vent devices, which operate by thermal ascending force and by automatic fire recognition devices (thermal detector, smoke detector), and they release either self-acting or manual by smoke detectors at an early stage of a fire, and remain in opened position without further power consumption. In these cases, functioning preservation of the electrical line system is required only at an early stage of fire. Protected wiring is required with protection against mechanical damages according to DIN 18232 section 2.5.5 paragraph 4.

Control Cable (Group):

Cable from the smoke vent control panel to connection of drive (drive lines have a monitoring wire, in which fire recognition devices (thermal maximal detector e.g. THE) can be looped-in):

- Safety line, with functional conservation ... E30, according to DIN 4102* or standard guidelines for line systems MLAR.

Detector Cables (Line):

The detector cables are monitored for short circuit and for break.

The opening device is automatically triggered and opens up in case of fault, when DIP-switch 7 is on ON.

Smoke vent button cable and cable of automatic detectors:

- weak current sheathed flexible cable YR 6 x 0.8
or
- house wiring cable IY(ST)Y 4 x 2 x 0.6

Cables through areas not monitored:

An increased time of functioning of the cable can be required, when drive lines are installed through building parts, which are not monitored.

- Safety line with functional conservation ... E90, according to DIN 4102* or standard guidelines for line systems MLAR.

(see supplementary sheet 1 to DIN VDE 0108)

** Notice: No type designation is given for these cables, because of a large variety on the market. Please consult your D+H distributor about these.*

Line lengths and Cross sections:

Number of wires and cross-sections indicated, refer to required lines only. In case of using a line with earthed conductor (green/ yellow), this one will not be counted in and must not be wired.

Typ / type		RZN 4404-K								
		RZN 4402-K								
Antriebe / drives	0,5A	1	2	3	4	5	6	7	8	
	1A		1		2		3		4	
	3 x 1,5mm ²	240	120	80	60	48	40	34	30	m
	3 x 2,5mm ²	400	200	130	100	80	65	55	50	m
*	5 x 2,5mm ²	800	400	260	200	160	130	110	100	m

cross section (mm²) = $\frac{\text{plain cable length (m)} \times \text{number of drives}}{80^{**}}$

* Connect in parallel 2 wires for each drive line.

** Only valid for drives with 1A actuating current. Use „160“ for drives with 0,5A actuating current and „230“ for drives with 0,35A actuating current.

Standard Connection

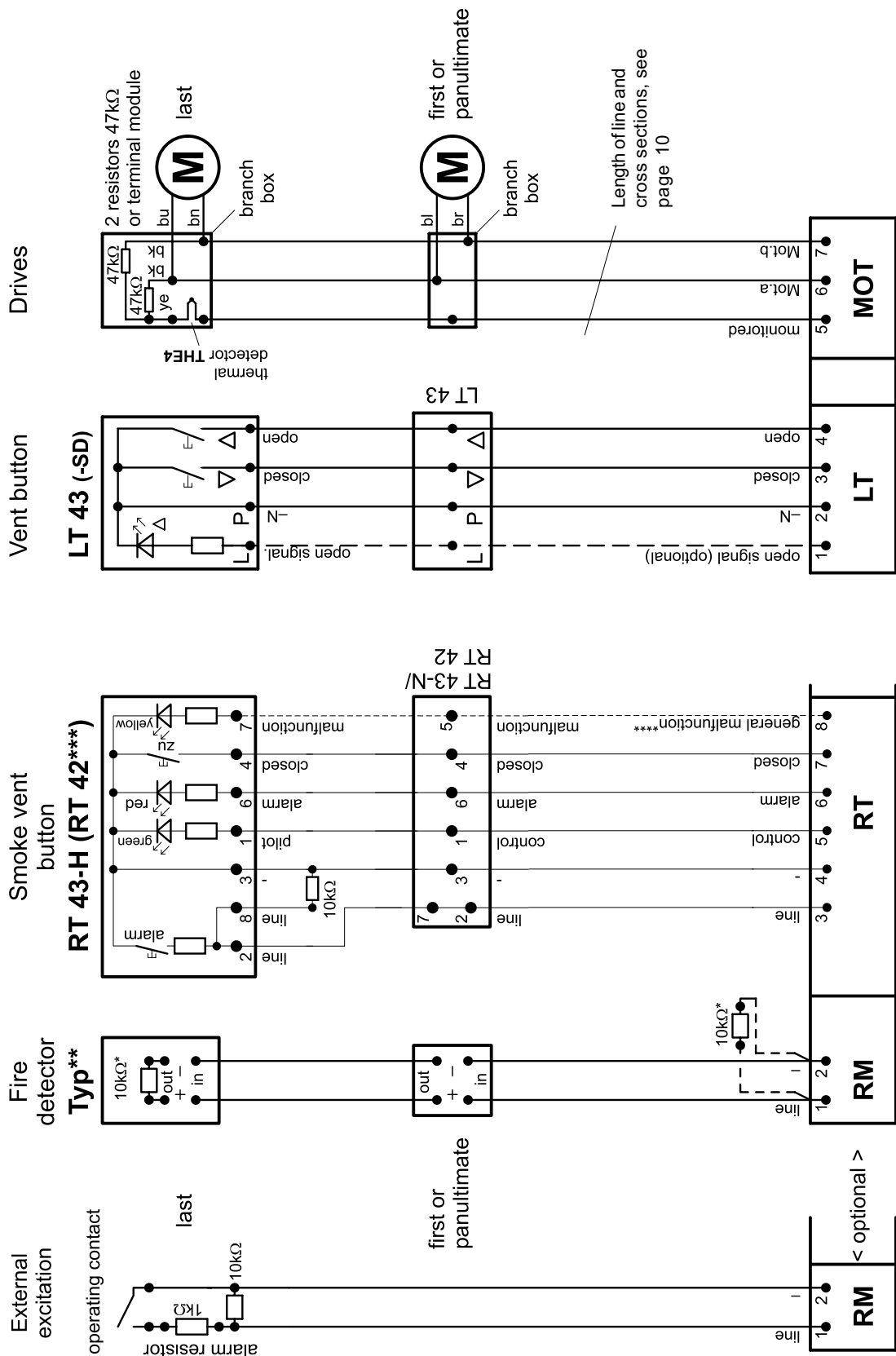

*** Terminal resistors for line monitoring:**
 They are pinched in control panel for transport. Take it off there and connect according to plan.
 Terminal resistors must remain at binder RM 1,2, when no fire detector or external control exists.

**** Fire detectors**
 Only D+H system approved detectors must be used.

***** Connection RT 42**
 The terminal resistor (10KW) must be screwed between binder 3 and 7, if RT 42 is used as ultimate smoke vent button.

****** No collective malfunction in case of smoke vent button RT 42**

Parallel Connection of Smoke Vent Buttons

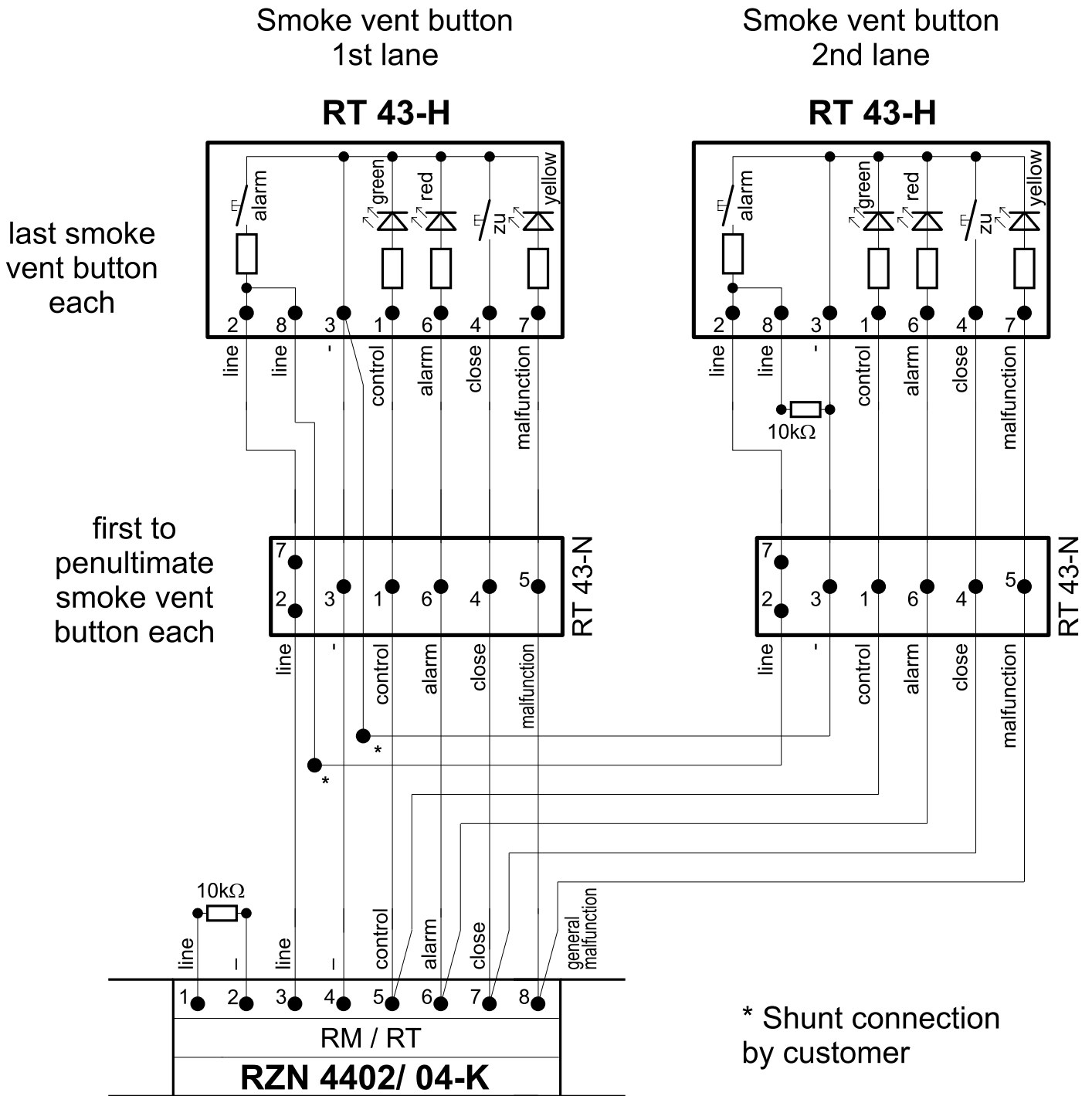

Connection of magnetic clamps on RZN 4400-K

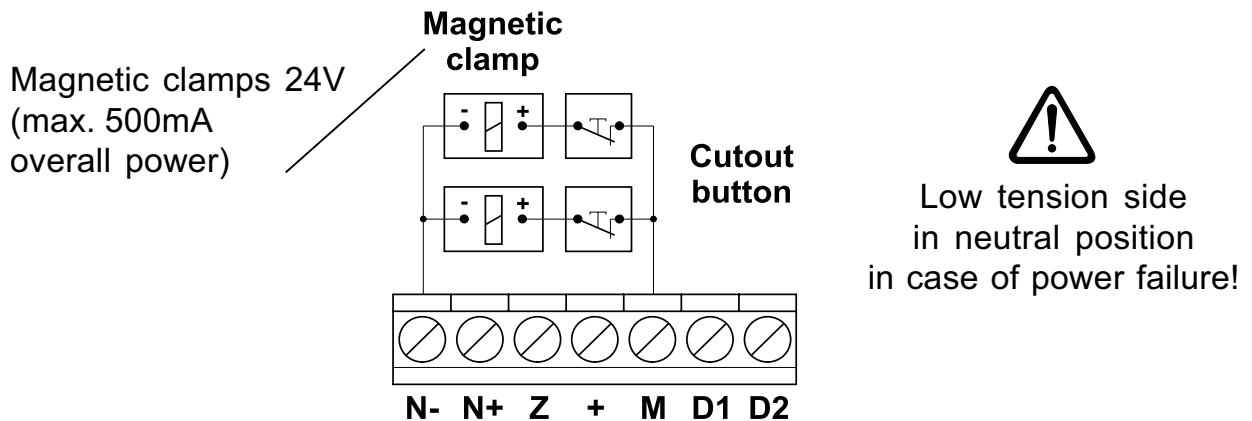

Connection Examples

Connection with line derivation:

supply wires **Mot a / Mot b** derive off in parallel, **monitoring** will be looped through all cables up to group end.

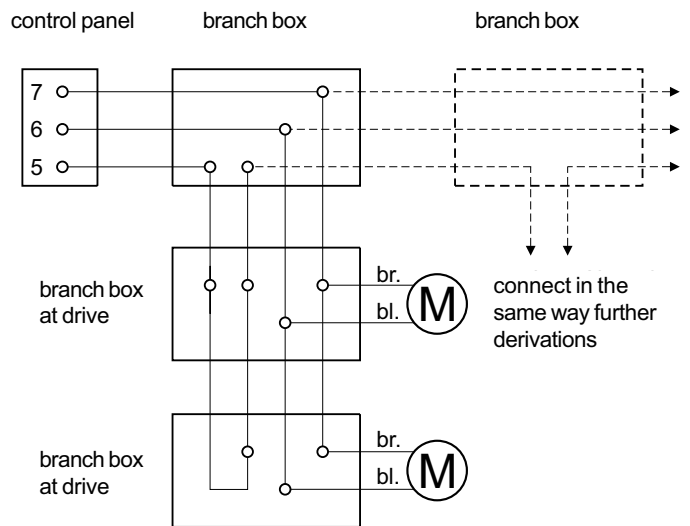

Example 1: 1 line

Simple installation, but unfavourable for voltage drop: All drives on one line.

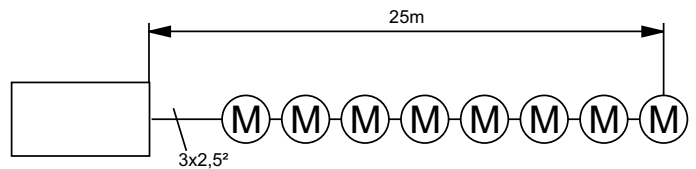

Example 2: 2 lines

Control panel in centre, one side wired as derivation, the other as terminal line. Observe 4 wires for derivation!

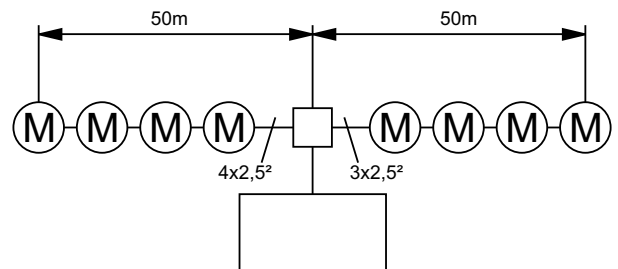

Example 3: 2 lines on one side

Derivation and terminal lines in same direction; number of drives vary according to length of line. Observe 4 wires for derivation!

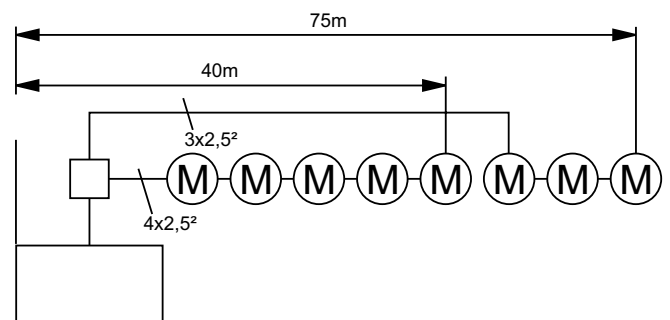

Example 4: 3 lines

3 lines are installed due to extremely long distances: 2 lines with 3 drives each on 75 m line as derivation, and 1 line with 2 drives on 200 m line.

Observe 4 wires for derivation!

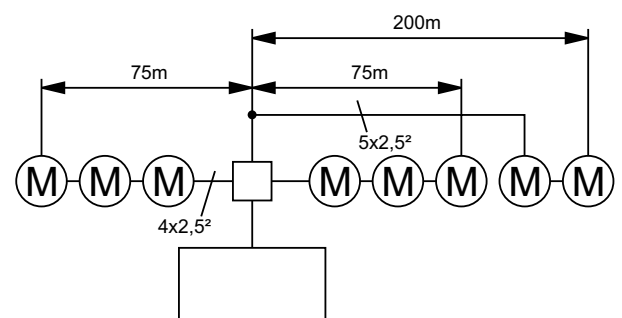

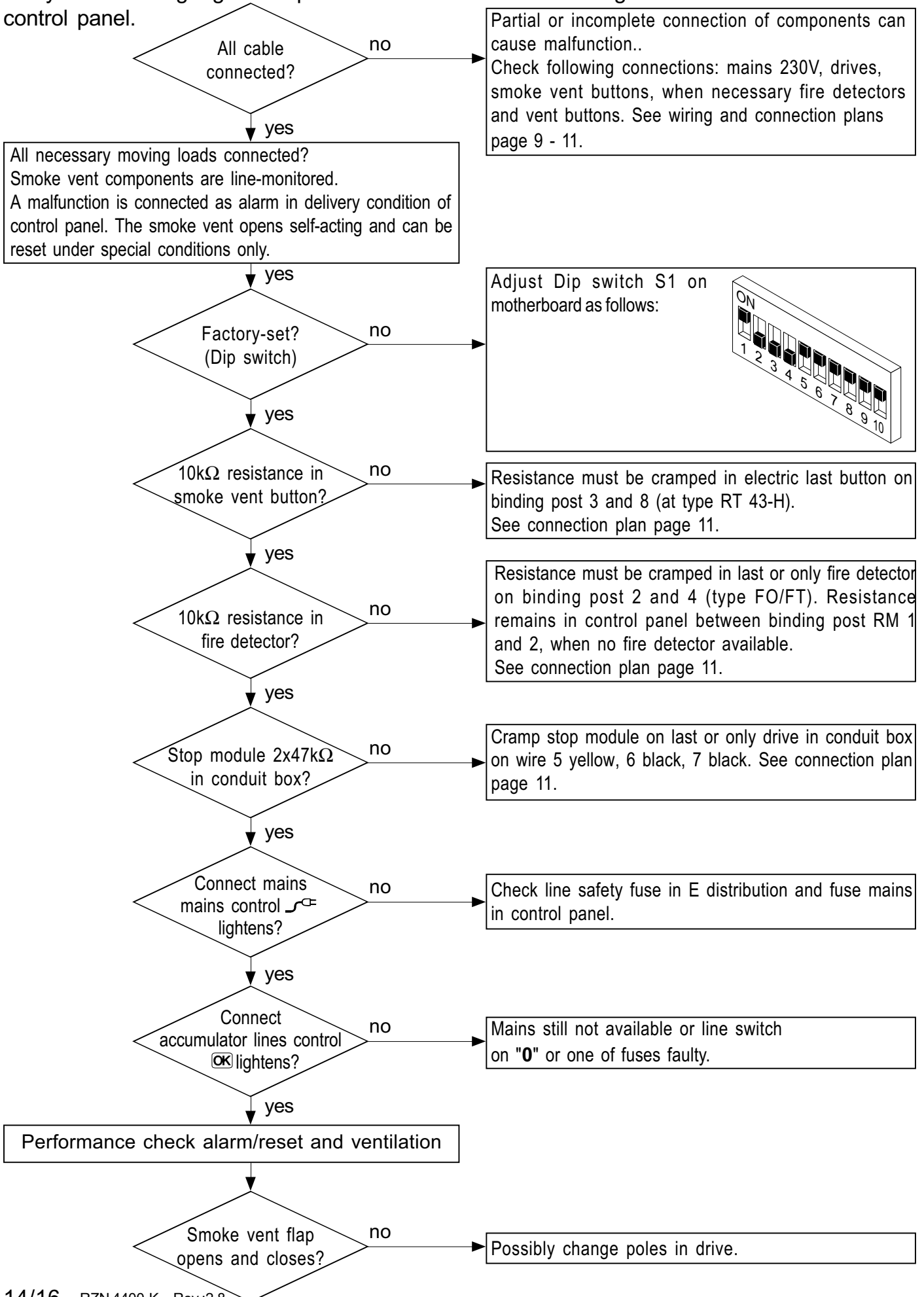

Informations for Starting

Carry out following sight and performance checks for switching-on the smoke and heat vent control panel.



Encode of Line and Group

Following functionings can be set with Dip switch (S1) on motherboard.

Dip switch 1 on ON = OPEN-running time limitation. Using a potentiometer  , running time in Open direction can be limited. If the vent button is actuated in Open direction, the drive will run open as long as the running time is set.
Dip switch 2 on ON = Ventilation time limitation. Using a potentiometer  , ventilation time can be set. Drives will automatically close again, after the adjusted time has expired.
Dip switch 3 on ON = OPEN-retriggering. If Dip switch 1 is switched on ON, the OPEN-running time limitation can be retriggered again.
Dip switch 4 on ON = Power failure-CLOSED. If the power supply breaks down, the drive will close. Only if Dip switch 5 = ON
Dip switch 5 on ON = Ventilation flap close up to final position by single pressing on vent button. When dip switch 5 is switched on OFF, flaps are closing only so long as the vent button is pressed. Closing of flaps by smoke vent button and OPEN-display on vent button is no longer possible then! If Dip switch 5 is on OFF, the function power failure-CLOSED will be ineffective (see Dip switch 4).
Dip switch 6 on ON = Ventilation flap opens up to final position by single pressing on vent button. If Dip switch 6 is connected on OFF, the flaps will only open as long as the vent button is pressed.
Dip switch 7 on ON = The control panel will be switched on alarm, that means the smoke vent opens at a line fault (e.g. at an interrupted detector line or short circuit).
Dip switch 8 on ON = The control panel will be switched on alarm, that means, the smoke vent opens in case of group fault (e.g. in case of an interrupted control line). Dip switch 8 must be on ON in conjunction with a ground in thermal maximal detector (e.g. THE 4).
Dip switch 9 on ON = Smoke detector alarm can not be reset by single pressing on button  in smoke vent button. Dip switch 9 must be switched on OFF, when remote reset is desired of smoke detectors by the smoke vent button .
Dip switch 10 on ON = The smoke vent is triggered for a duration of 30 minutes in intervals of 2 minutes according to VdS 2581.

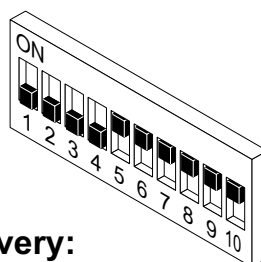

**Set position of
Dip-switch at delivery:**

Examination

Every six months and after repair by a specialist or staff, who has been introduced to the task.
Eliminate failings at once. Keep control book.

Preparation:

Notify user, that the system is out of operation before starting with inspection.

Notify user about false alarms.

Interrupt or switch off monitored alarm indication and remote controls.

Information

An overdue maintenance of the system will be indicated by the control panel after about 16 months. The yellow control diode in the smoke vent button RT43-H will start flashing.

A malfunction in the smoke vent system will be continually indicated by the extinguished green control diodes in the smoke vent buttons.

After the maintenance time is expired (16 months), the ventilation function OPEN can be interrupted depending on the presetting of the service timer. Reset can be carried out by a specialist company only, who has been authorized by the appliance manufacturer.

Inspection:

Check all appliances and cable connections for outer damage and dirt accumulation.



Fire detectors, smoke vent buttons, smoke vents and so on must not be impaired in their function by goods in storage or structural changings.

Smoke vent button:

Open smoke vent button.

Press red button , red display diode  lightens in button and control panel.

Smoke vent must open.

Press masked button (1 sec.), red display diode  extinguishes in button and control panel.

Smoke vent must close.

Automatic fire detectors:

Release smoke detector individual by D+H-smoke detector tester, as an alternative by

cigarette smoke (response delay circa 20 sec.).

Red display diode must lighten.

Smoke vent must open.

For closing wait until there is no more smoke in detector.

Reset line in control panel (switch off/ switch on press button), red display diode  extinguishes in button and control panel.

Press masked button  in smoke vent button. Smoke vent must close.

The line can also be directly reset via smoke vent button, if Dip switch 9 is switched on OFF. For this, press masked button  in smoke vent button (for 1second).

Red display diode  extinguishes in button and in control panel.



At severe dirt accumulation visible from outside, send detector in for maintenance and install another one.

External control (optional):

Release external control.

Smoke vent must open.

Open contact in external system for closing, for example by resetting of fire detector system.

Press masked button  in smoke vent button (1second). Red display diode  extinguishes in button and control panel.

Smoke vent must close.

Emergency supply:

Detach fuse MAINS on motherboard of control panel.

Green mains indication diode  on control panel must not lighten.

Repeat functioning testing.

Green control diode  in smoke vent buttons must not lighten.

If Dip switch 4 and 5 on ON, the group will be automatically closing.